

BRETT B.
B.B.



Year 11 Physics Semester 1 Examination 2020 Question & Answer Booklet

Name: - MASTER - B.B. - UPDATED

Teacher: _____

Time allowed for this paper:

Reading time before commencing work: 10 minutes

Working time for paper: 2.5 hours

Materials required/recommended for this paper

To be provided by the supervisor

This Question/Answer Booklet

Formulae and Data Booklet

To be provided by the candidate

Standard items: pens, pencils (including coloured), sharpener, correction fluid, eraser, ruler, highlighters.

Special items: up to three non-programmable calculators approved for use in the WACE examinations, drawing templates, drawing compass and a protractor.

	Q	M	Amolated
M.P	1-9 INC	42	✓
B.D	10-15ci	61	✓
B.B	15 GRP →	42	

STRUCTURE OF THIS PAPER

Section	Questions	Questions to be attempted	Suggested working time (mins)	Marks available	Percentage of exam
Section One: Short Response	11	11	57	55	38 %
Section Two: Problem Solving	5	5	75	72	50 %
Section Three: Comprehension	1	1	18	18	12 %
Total				145	100 %

INSTRUCTIONS TO CANDIDATES

1. Write your answers in the spaces provided beneath each question. The value of each question is shown.
2. Answers to questions involving calculations should be evaluated and given in decimal form. Final answers should be given up to three significant figures and include appropriate units.
3. Questions containing the instruction "**ESTIMATE**" may give insufficient numerical data for their solution. Give final answers to a maximum of two significant figures and include appropriate units.
4. Despite an incorrect result, credit may be obtained for method and working providing these are clearly and legibly set out.
5. Questions containing specific instructions to **show working** should be answered with a complete, logical, clear sequence of reasoning showing how the final answer was arrived at; correct answers which do not show working will not be awarded full marks.
6. Supplementary pages for the use of planning/continuing your answer to a question have been provided at the end of this Question & Answer booklet. If you use these pages to continue an answer, indicate at the original answer where the answer is continued, i.e. give the page number.
7. A spare graph has also been provided at the end of this Question & Answer booklet.

Section One: Short Response

38% (55 marks)

This section has 11 questions. Answer all questions. Answer the questions in the spaces provided.
Suggested working time: 57 minutes.

Question 1

(4 marks)

The diagrams below show the changes which occur between the solid, liquid and gaseous phases of a substance, with the addition of heat.

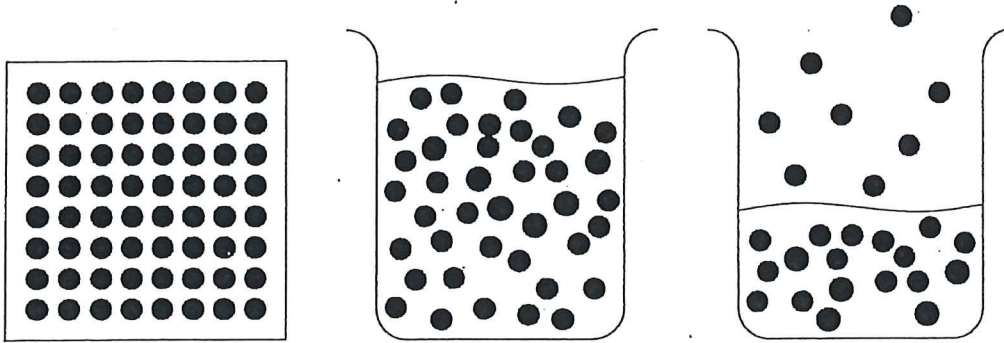

Using these diagrams and your knowledge of the kinetic particle model, state and explain one change which occurs when the substance changes phase from:

(a) solid to liquid.

(2 marks)

• MELTING ①

• MORE ROTATIONAL AND OR TRANSLATION MOTION OF PARTICLES. ①

(b) liquid to gas.

(2 marks)

• EVAPORATION ①

• MORE TRANSLATION MOTION OF PARTICLES. ①

OR
• MORE KINETIC ENERGY (E_k) OF PARTICLES.

Question 2

Identify the products V, W, X, Y and Z in the following nuclear equations.

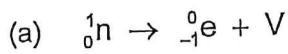

V = PROTON 1_1p OR $(1) \text{ } \alpha \text{ } \text{ET.}$



W = POSITRON 0_1e

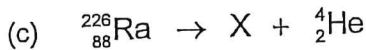

X = RADIUM - 222 ${}^{222}_{86}\text{Rn}$

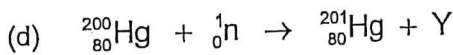

Y = GAMMA RADIATION γ

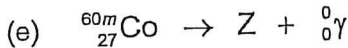

Z = COBALT - 60 ${}^{60}_{27}\text{Co}$

Question 3

(3 marks)

In cold climates, wind chill factor and hypothermia can pose a real threat to the health of an individual. Wind chill is when cooler moving air replaces relatively still air near a person's skin, giving the person the sensation that the effective temperature has decreased. Explain why the cooling effect on the person is increased if the person is wet or wearing wet clothes.

- WATER HAS A HIGH SPECIFIC HEAT. (1)
- THAT IS, THE WATER CAN CONTAIN A LARGE QUANTITY OF HEAT PER UNIT MASS. (1)
- WHEN WATER ON THE SKIN OR CLOTHES EVAPORATES, IT CAN TAKE A LOT OF HEAT AWAY FROM THE BODY AND TRANSFER IT TO THE SURROUNDING AIR. (1)

Question 4

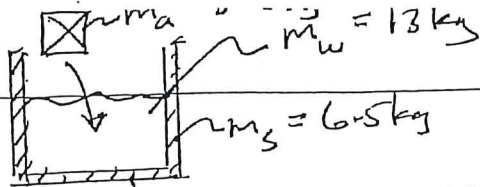

(5 marks)

A 6.50 kg steel container (specific heat capacity $4.50 \times 10^2 \text{ J kg}^{-1} \text{ K}^{-1}$) holds 13.0 kg of water at 24.0°C . When 3.15 kg of a molten alloy, at its melting point of 315°C , is poured into the water, the water reaches a final temperature of 29.1°C . If the latent heat of fusion of the alloy is $2.30 \times 10^4 \text{ J kg}^{-1}$ determine the specific heat capacity of the alloy.

$$Q_L = Q_G \quad \text{RHS} \quad 315^\circ \text{C}$$

$$[(m_a L_f) + (m_a c_a \Delta t_1)] = [(m_s c_s \Delta t_2) + (m_w c_w \Delta t_2)] \quad \text{①}$$

$$(3.15 \times 2.30 \times 10^4) + (3.15 \times L \times 285.9) = [6.5 \times 450 \times 5.1] + (13 \times 4180 \times 5.1)$$

$$\text{For (c)} \quad \therefore 900.585 L = (1.49175 \times 10^4 + 2.77134 \times 10^4) - 7.245 \times 10^4$$

$$\therefore L = \frac{2.9205 \times 10^5 - 7.245 \times 10^4}{900.585}$$

$$= 243.84$$

$$= 244 \text{ J kg}^{-1} \text{ K}^{-1} \quad \text{①}$$

IF INC. UNITS

① FOR EA MASSOR ERROR i.e IF $(m_s c_s \Delta t_2)$ NOT CALCULATED (5 marks)

Question 5

Albert is trying to precisely measure the resistance R of a piece of fuse wire. To do so he applies a voltage across the wire and measures current passing through the wire. The meters are shown below.

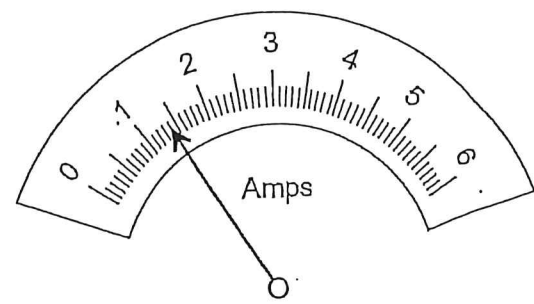
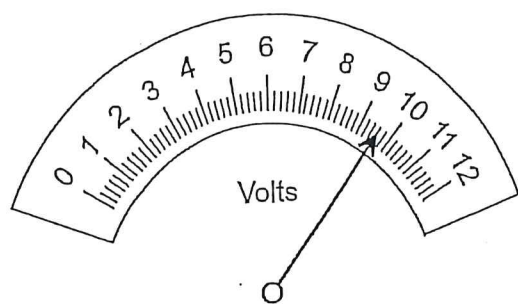

Determine the resistance R of the fuse wire.

Give your answer in the form $R \pm \Delta R$ (ΔR being the uncertainty in the resistance value).

$$R_{\text{true}} = \frac{V}{I}$$

$$= \frac{9.6}{1.4}$$

$$= 6.8571$$

$\% R = \% V + \% I$

VAR		\pm	$\%$
V	9.6	0.10	1.04
I	1.4	0.05	3.57
R	6.8571	0.13	4.61%

0.1 - WATCH OUT!
WATCH OUT!

Now For \pm METHOD ①

$$\left(\frac{6.8571 \times 4.61}{100} = 0.32 \right)$$

$$\text{AVS } R = 6.8 \pm 0.13$$

$$\text{2 s.f. ONLY OR } 0.2$$

Question 6

(5 marks)

Domestic smoke detectors use about 0.25 μg of a radioactive source of Americium-241 which produces alpha particles. Under normal operating conditions, the alpha particles ionise oxygen and nitrogen molecules in the air and an electric potential from a battery causes a small ionisation current to flow. When smoke enters the detector the smoke particles absorb alpha particles and thus reduce the ionisation current flowing in the circuit, setting off an alarm.

- (a) Explain the effect that using a radioactive source which produces beta particles instead of alpha particles would have, on the operation of a domestic smoke detector. (2 marks)

- β PARTICLES ARE LESS IONISING THAN α PARTICLES. (1)
- THE DETECTOR CIRCUIT WILL GO OPEN CIRCUIT (ELECTRICITY WILL NOT FLOW) AND THE ALARM WILL SOUND CONTINUOUSLY. (1)

- (b) If the half-life of Am-241 is 450 years, how much of the original radioactive material would be left in an old smoke detector that is 50 years old. (3 marks)

FOR (A)

$$A = A_0 \cdot 0.5^n \quad (1)$$

$$\therefore n = \frac{50}{450} = 0.111 \quad (1)$$

Now $A = 0.25 \times (0.5)^{0.111}$
 $= 0.231 \mu\text{g}$ OR $2.31 \times 10^{-7} \text{ g}$ (1)

Question 7

(5 marks)

A 416 g sample of radioisotope Promethium-147 decays into Samarium-147 as the main product. Promethium can be found in the Lanthanide series at the bottom of the periodic table.

- (a) Write a balanced nuclear equation for Promethium-147 decaying to Samarium-147. (2 marks)

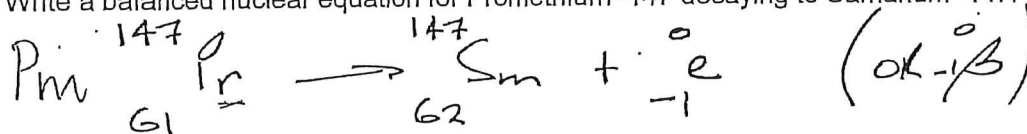

- (b) Determine the half-life of Promethium-147 if the original sample decays to 13.0 g in 12.0 years? (3 marks)

FOR ($t_{1/2}$)

$$A = A_0 (0.5)^n \quad (1)$$

$$13 = 416 (0.5)^n$$

$$\therefore \frac{13}{416} = 0.5^n$$

$$\Rightarrow n = 5.0 \quad (1)$$

Now $t_{1/2} = \frac{12}{5} = 2.4 \text{ yrs}$ (1)

Question 8

(6 marks)

After running a long-distance marathon, Tori adds a handful of ice blocks to her partly empty water bottle. Tori knows that an average ice block contains anywhere from 30.0 to 50.0 mL of water. Tori also wants to ensure that the ice doesn't melt too quickly and therefore only selects ice blocks that are well below freezing point. Using this information, estimate how many kilojoules (kJ) of energy were extracted from tap water in order to produce the ice blocks which Tori used. State key assumptions.

ASSUMPTIONS

$$m = 0.106 \rightarrow 0.3 \text{ kg} \text{ (1)}$$

$$t = 30 \rightarrow -10.0 \text{ (1)}$$

$$Q = (mcs\Delta t_1) + (mLf_f) + (mcs\Delta t_2) \quad \boxed{3} \text{ FOR METHOD}$$

$$Q \approx 6 - 144 \text{ kJ} \text{ (1)}$$

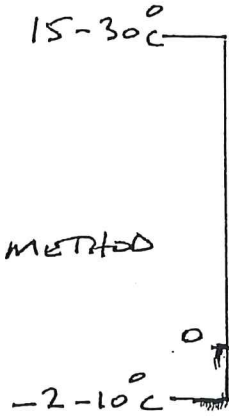

Question 9

(4 marks)

The label on a rechargeable Lithium-Polymer (LiPo) battery reads: "11.1 volt, 1800 mAh". The battery is being used to operate a remote-control vehicle.

- (a) The term "1800 mAh" refers to which quantity below? Circle your answer. (1 mark)

Current

Time

Energy

Charge

- (b) Given that the electric motor of the vehicle draws a constant current of 12.0 A from the battery during an operating time of 9.00 minutes, calculate the efficiency of the motor, if the motor produces 5.80×10^4 J of useful energy. (3 marks)

FOR (E_{INPUT})

$$E = VIt \quad \left(\frac{1}{2}\right)$$

$$= 11.1 \times 12 \times 9 \times 60$$

$$= 7.1928 \times 10^4 \text{ J} \quad \left(\frac{1}{2}\right)$$

Now $\text{EFF} = \frac{E_{\text{OUT}}}{E_{\text{IN}}} \times \frac{100}{1} \quad \left(\frac{1}{2}\right)$

$$= \frac{5.80 \times 10^4}{7.1928 \times 10^4} \times \frac{100}{1} \quad \left(\frac{1}{2}\right)$$

$$= 80.63\%$$

$$= \underline{80.6\%} \text{ (1)}$$

10

Question 10

(5 marks)

Two motors, which initially have equal resistance (R), are running in parallel with each other and are powered by the same voltage source V .

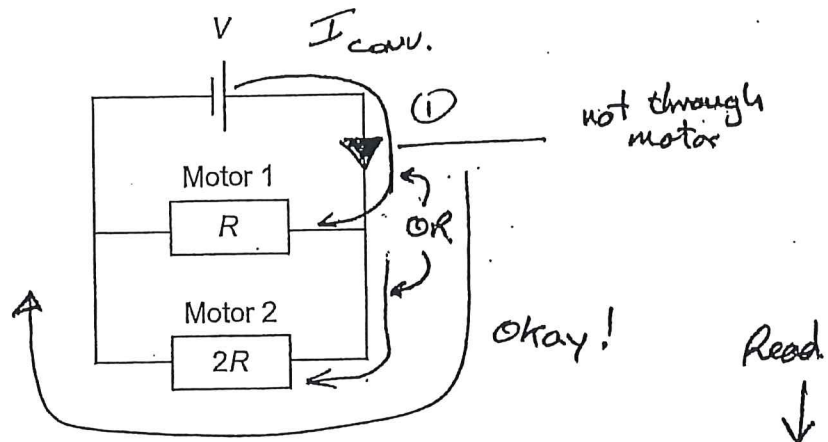

- (a) On the diagram above, indicate with an arrow, the direction of conventional current through one of the motors. No calculations are involved. (1 mark)
- (b) Due to unusual heating of the wires in Motor 2, Motor 2's resistance doubles from R to $2R$ (as indicated on the diagram above). Show mathematically the overall circuit current before the heating of Motor 2 and after the heating of Motor 2.

Hint: Use R for Motor 1's resistance and $2R$ for Motor 2's resistance after heating. (4 marks)

FIND $R_{||}$ FIRST

$$\frac{1}{R_{|| \text{ COLD}}} = \frac{1}{R} + \frac{1}{R} \dots$$

$$\therefore R_{|| \text{ COLD}} = \frac{R}{2} = \underline{0.5R \text{ OR } \frac{1}{2}R} \text{ (1)}$$

AND $\frac{1}{R_{|| \text{ HOT}}} = \frac{1}{R} + \frac{1}{2R}$

$$\therefore R_{|| \text{ HOT}} = \frac{2R}{3} = \underline{0.66R \text{ OR } \frac{2}{3}R} \text{ (1)}$$

Now $I_{\text{COLD}} = \frac{V}{R} = \frac{V}{0.5R} \text{ OR } \frac{V}{\frac{1}{2}R} \text{ (1) } \frac{2V}{R}$

$$I_{\text{HOT}} = \frac{V}{R} = \frac{V}{0.66R} \text{ OR } \frac{V}{\frac{2}{3}R} \text{ (1) } \frac{3V}{R}$$

IF $I = \left(\frac{1}{R} + \frac{1}{R}\right)^{-1}$ (cold)

$I = \left(\frac{1}{R} + \frac{1}{2R}\right)^{-1}$ (hot) 2 only!

Question 11

(8 marks)

The heating curve below shows the temperature change of a 285 g sample of solid coconut oil as it is heated, with a small 40.0 W heating element, from an initial temperature of 10.0 °C.

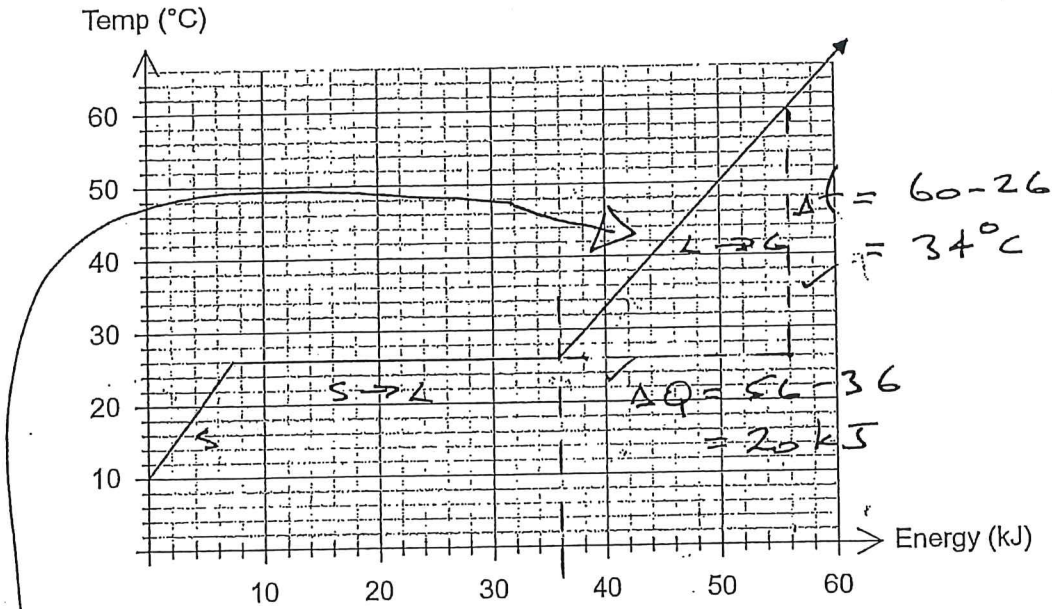

- (a) How long does it take for the coconut oil to completely melt? (3 marks)

$$E_{\text{Tot. melt}} = 36 - 7 = 29 \text{ kJ} \quad \text{--- (1)}$$

$$P = \frac{E}{t} \quad \text{--- (2)}$$

$$t = \frac{E}{P} = \frac{29 \times 10^3}{40} = 7.25 \text{ s} = 7.3 \times 10^2 \text{ s} \quad \text{(2 or 3 s.f. o.k.)}$$

- (b) Use the graph to estimate the specific heat capacity of liquid coconut oil. Show construction lines on your graph which are used to define values. (5 marks)

(2)

$$Q = mc\Delta t$$

$$c \approx \frac{Q}{m\Delta t} \quad \text{--- (1)}$$

$$\approx \frac{20 \times 10^3}{0.285 \times 34} \quad \text{--- (1)}$$

$$\approx 2.06 \times 10^3 \text{ J kg}^{-1} \text{ K}^{-1} \quad \text{--- (1)}$$

$$\rightarrow \text{ACCEPT } [1.9 \rightarrow 2.25 \times 10^3] \quad \text{--- (1/2)}$$

watch

H1	L0
21×10^3	19×10^3
0.285×33	0.285×35
$= 2.23 \times 10^5$	$= 1.90 \times 10^5$

END OF SECTION ONE

Section Two: Problem Solving

50% (72 marks)

This section contains 5 questions. Answer all questions. Answer the questions in the spaces provided.
Suggested working time 75 minutes.

Question 12

(13 marks)

Consider the circuit shown below, containing four resistors, an ammeter and a voltmeter.
The following parts of the question relate to the diagram below.

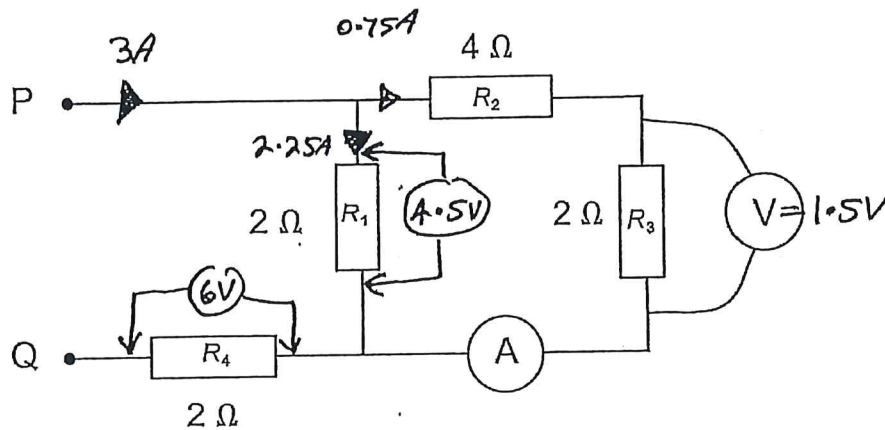

- (a) Show that the total resistance between terminals P and Q is 3.50Ω .

(4marks).

REDRAW/SIMPLIFY CIRCUIT

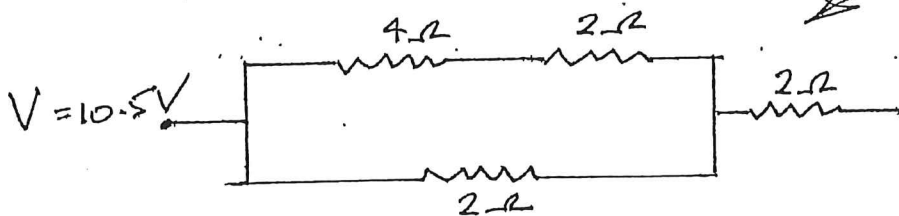

DRAWING IS
OPTIONAL.

FIRSTLY, FOR R_{11}

$$\frac{1}{R_{11}} = \frac{1}{6} + \frac{1}{2} \quad (1)$$

$$= \frac{1+3}{6} \quad (1)$$

$$\therefore R_{11} = \frac{6}{4} = 1.50\Omega \quad (1)$$

$$\text{Now } R_{P-Q} = 1.50 + 2 = \underline{3.50\Omega} \quad (1)$$

WATCH C.O

(b) If a voltage source of 10.5 volts is placed across the terminals P and Q:

i) Find the total current drawn by the circuit. (1 mark)

$$I_{TOT} = \frac{V_{TOT}}{R_{TOT}} = \frac{10.5}{3.50} = 3.00 \text{ A}$$

L (sf ignore)

ii) Find the amount of charge drawn by the circuit in a time of 45.0 seconds. (2 marks)

$$I = \frac{q}{t} \quad \text{①}$$

$$\therefore q = I t = 3.00 \times 45 = 135 \text{ C}$$

L ①

WATCH C.O

iii) Show that the current measured at the ammeter is 0.750 A. (4 marks)

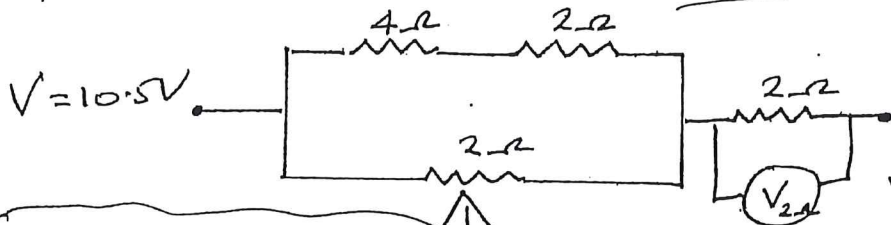

MULTIPLE METHODS !!

$$V_{2\Omega} = I_{TOT} \times 2\Omega$$

$$= 3 \times 2$$

$$= 6.00 \text{ V} \quad \text{①}$$

Now $V_{||} = V_{TOT} - 6.00 \quad \text{①}$

$$= 10.5 - 6.00$$

$$= 4.50 \text{ V} \quad \text{①}$$

AND $I_{TOT \text{ AM}} = \frac{V_{||}}{6\Omega} = \frac{4.50}{6.00} = 0.750 \text{ A} \quad \text{①}$

iv) Determine the voltage measured by the voltmeter in the original circuit diagram. (2 marks)

Ratio...

$$I_T = 3 \text{ A}$$

$$I_T = x + \frac{6}{2}x$$

$$x = 0.750 \text{ A}$$

$$V_{2\Omega} = I R_3 \quad \text{①/2}$$

$$= 0.750 \times 2 \quad \text{①/2}$$

$$= 1.50 \text{ V} \quad \text{①}$$

R₃

WATCH C.O

Question 13 $-\frac{1}{2}$ each error. -1 NO 2_0^1n $2_0^1n \neq 2_0^2n$ (17 marks)

A 900 MW fission reactor uses a Uranium-enriched fuel source containing Uranium-235. This fission reaction involves the absorption of Uranium-235 (235.04393 u) with a single neutron (1.00866 u) which produces Strontium-94 (93.91536 u), Xenon-140 (139.92164 u), and a number of neutrons and energy.

- (a) Write a balanced nuclear equation for the neutron bombardment of Uranium-235 described above and clearly state the number of neutrons produced. (3 marks)

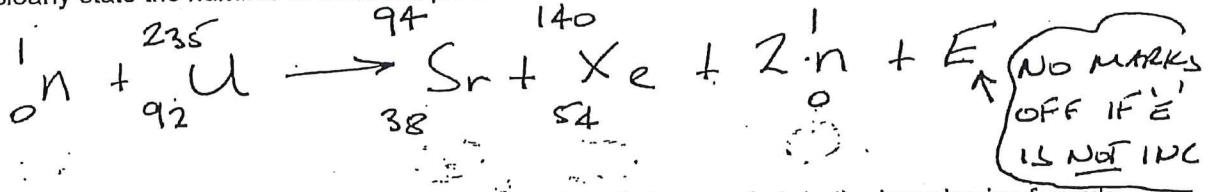

- (b) State why you selected the number of neutrons produced above and state the key physics formula which can be used to determine the energy released from the nuclear reaction above. (2 marks)

NEUT
 E/
 OR
 =

- conservation of mass
- MASS NO: REACTANTS = MASS NO: PRODUCTS ①
- Not 'Balance equation'.
- $\Delta m \Rightarrow u \Rightarrow \text{MeV}$
- $\Delta m \Rightarrow \text{kg} \Rightarrow E = mc^2$ ①

IF ONLY $\Delta m = m_r - m_p$
 ①/2 ONLY

OR SIMILAR

- (c) Calculate the amount of energy, in joules, produced by this nuclear reaction. Show clear and methodical working. (5 marks)

FOR Δm

$3.091847299 \times 10^{-25}$
 $- 3.915181712 \times 10^{-25}$
 $= 3.291282 \times 10^{-28} \text{ kg}$

check part (c)

$\Delta m = m_r - m_p$
 $\Rightarrow (1.00866u + 235.04393u) - (93.91536u + 139.92164u + 2(1.00866u))$
 $= 236.05259u - 235.85432u$
 $= 0.19827u$ ①

$u \rightarrow \text{MeV}$
 $\text{MeV} = 0.19827u \times 931$
 $= 184.589 \text{ MeV}$ ①

$\text{MeV} \rightarrow \text{J}$
 $\Rightarrow 184.589 \times 1.60 \times 10^{-13}$
 $= 2.9534 \times 10^{-11}$
 $= 2.95 \times 10^{-11} \text{ J}$ ①

OR
 $u \rightarrow \text{kg}$
 $0.19827u \times 1.66 \times 10^{-27}$
 $= 3.29128 \times 10^{-28} \text{ kg}$ ①

Now $E = mc^2$
 $= 3.29128 \times (3 \times 10^8)^2$
 $= 2.962 \times 10^{-11}$
 $= 2.96 \times 10^{-11} \text{ J}$ ①

① IF INCORRECT

11/3 ① $\Delta m = 1.20703u$ $E = 1.803 \times 10^{-10} \text{ J}$ ⑤

10

Different methods:

- (d) Calculate the mass, in kilograms, of Uranium-235 fuel required to operate this 900 MW nuclear reactor for one year. Note: if you did not calculate part (c), you may use a value of 3.00×10^{-11} J for the energy released per fission reaction of Uranium-235.

Check!!!

State all assumptions and show clear and methodical working.

FIRSTLY, FIND TOT. ENERGY REQUIRED.

$$E = Pt$$

$$= 900 \times 10^6 \times 365 \times 24 \times 3600$$

$$= 2.83824 \times 10^{16} \text{ J} \quad \text{--- (1)}$$

(4 marks)

ASSUMPTIONS

a. 100% EFF

$m \rightarrow E$

b. 365 d/yr

NOW, FOR NO. FISSIONS REQ.

$$No: = \frac{E_{REQ}}{E_{PER FISS}} = \frac{2.83824 \times 10^{16}}{2.9534 \times 10^{-11}} = 9.61007 \times 10^{26} \text{ FISSIONS} \quad \text{--- (1)}$$

LASTLY, FOR m, U-235 REQ

$$m_{U-235} = 235.04393 \text{ u} \times 1.66 \times 10^{-27} \times 9.61007 \times 10^{26}$$

$$= 374.95 \text{ kg} \quad \text{--- (1) OR}$$

$$= 375 \text{ kg U-235}$$

WATCH C.O

PERIOD. TABLE

MOLAR MASS: 238

$$m = \frac{9.61007 \times 10^{26} \times 238}{6.02 \times 10^{23}}$$

$$= 379.933$$

$$= 380 \text{ kg}$$

- (e) A radiation limit for workers at the nuclear reactor facility is set at 100.0 mSv per year. If an 82.0 kg worker at the nuclear reactor accidentally receives a full body exposure of 12.0 J of beta radiation from spent fuel rods, determine the worker's absorbed dose, dose equivalent and state if it is safe for the worker to continue working. (3 marks)

FOR AD

$$AD = \frac{E}{m} = \frac{12}{82} = 0.146 \text{ Gy} \quad \text{--- (1)}$$

$\frac{\text{J kg}^{-1}}{\text{--- OR ---}}$

FOR D.E.

$$DE = AD \times QF = 0.146 \times 1 = 0.146 \text{ Sv} \quad \text{--- (1)}$$

$\frac{\text{Not J kg}^{-1}}$

SINCE D.E (146 mSv) > 100 mSv (must state...)

∴ IT IS NOT SAFE FOR THE WORKER.

(1/2)

Q13 (a) other methods

1/2

1. $M_u = 235.04393u$
 $\times 1.66 \times 10^{-27} = 3.901729 \times 10^{-25} \text{ kg}$

2. No of nuclei in 1 kg = $2.562966159 \times 10^{24}$ (1)

3. E in 1 nuclei = $2.962 \times 10^{-11} \text{ J}$ (watch 40) (2)

4. Total E req/ kg = (1) \times (2) = $7.591507 \times 10^{13} \text{ J}$ (3)
($7.6889 \times 10^{13} \text{ J}$)

5. E for 1 year = $900 \times 365 \times 24 \times 60 \times 60$ (4)
 $= 2.8382 \times 10^{16} \text{ J}$

6. \therefore mass = $\frac{(4)}{(3)} = \frac{2.8382 \times 10^{16}}{7.591507 \times 10^{13}} = 373.86 \text{ kg}$
(369.129 kg)

Q required = $2.8382 \times 10^{16} \text{ J}$ - (1)

Q nuclei = $2.962 \times 10^{-11} \text{ J}$ - (2)

$\frac{(1)}{(2)} = 9.5882 \times 10^{26}$ No of reactions.

$M_{\text{Total}} = M_u \times \text{No of reactions}$

= $235.04393 \times 1.66 \times 10^{-27} \times 9.5882 \times 10^{26}$

= 373.87 kg

(369.1296 kg)

Q nuclei = 2.95×10^{-11}

mass = 375.39

$$W = Pt = \dots$$

$$= 2.83824 \times 10^{16} \text{ J}$$

$$E = mc^2 \Rightarrow \Delta m = \frac{2.83824 \times 10^{16}}{(3 \times 10^8)^2}$$
$$= 0.31536 \text{ kg.}$$

$$\text{Tot.} \rightarrow 1.899759 \times 10^{26} \text{ u}$$

$$\text{No of reactions} \times M_{\text{nucl.}} = M_{\text{req.}}$$

$$\frac{1.899759 \times 10^{26}}{0.019827} \times 235.04393 = 2.2521 \times 10^{29} \text{ u}$$

$$\rightarrow = 373.85 \text{ kg}$$

$$= \underline{374 \text{ kg}}$$

2/2